



PERIPHERAL INTERVENTION

INTERVENTION



INTERVENTION

DRAINAGE CATHETERS & ACCESSORIES

MAK-NV™ Introducer System	59
Valve Adapter for MAK-NV	60
ReSolve® Biliary Locking Drainage Catheters	61
ReSolve Locking Drainage Catheters	62
ReSolve+™ Locking Drainage Catheters	63
Resolve Locking Drainage Catheter Trays	64
ReSolve Non-Locking Drainage Catheters	65
One-Step™ Centesis Catheters	66
Safety Paracentesis Procedure Trays	67
Thoracentesis and Paracentesis Sets	68

CATHETER ACCESSORIES

Revolution™ Catheter Securement Device	69
StayFIX® Fixation Device	69

DRAINAGE ACCESSORIES

Merit Drainage Depot™ Drainage Bags	70
Abscess Drainage Kit	70
Drainage Kits	70
VacLok® Vacuum Pressure Syringes	71
Marquis® Series Stopcocks	72
Drainage Tubing	72
Connecting Tubes	72

SUPPORT CATHETERS 73

Merit SureCross® Support Catheters	
------------------------------------	--

INFLATION DEVICES

BasixCOMPAK™ Inflation Device	74
BasixTOUCH™ Inflation Device	74
BIG60™ Inflation Device	75
Blue Diamond™ Inflation Device	75

SNARES & ACCESSORIES

EN Snare® Endovascular Snare Systems	76
FLO 30™ Tuohy Borst Valved Adapter	76
ONE Snare® Endovascular Snare Systems	77

HAEMODIALYSIS & PERITONEAL DIALYSIS CATHETERS & ACCESSORIES

Merit Advance® Curved Needles	78
Prelude® Short Sheath Introducers	79
Impress® 30 cm Catheters	80
Centros® & CentrosFLO® Catheters	81
ProGuide™ Chronic Dialysis Catheters	82
ProGuide Basic Kits	82
ProGuide Complete Kits	83
ProGuide Complete Kits with Mini Access Kit	84
OuTake® Catheter Extraction Tool	84
Peritoneal Dialysis Catheters	85
Peritoneal Dialysis Accessories & Implantation Systems	86
Slip-Not® Suture Retention Device	87

THERAPEUTIC INFUSION SYSTEMS

4 French Fountain® Infusion Systems	88
5 French Fountain Infusion Systems	89
Fountain Infusion Catheters	90
Fountain Occluding Wires	91
Squirt® Fluid Dispensing System	91
Pulse Infusion Kits	91-92
Mistique® Infusion Catheters	92

MAK-NV™ (MINI ACCESS KIT, NON-VASCULAR) INTRODUCER SYSTEMS

The MAK-NV introducer system is designed for easy visualisation and quick access into the drainage area. For enhanced visibility, the device features an echo-enhanced needle and radiopaque marker tip on the introducer. Excellent transitions decrease buckling for a smooth insertion. Packaged 5 or 10 units per box.



Coaxial Introducer with Dilator and Stiffening Cannula

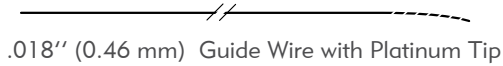

.018" (0.46 mm) Guide Wire with Platinum Tip

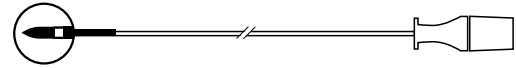

Introducer Needle with Trocar Stylet

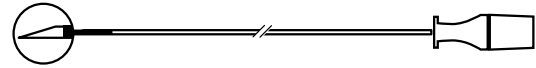

Introducer Needle with Chiba Stylet



0.038" (0.97 mm) 3 mm J Guide Wire
Heavy Duty Double Ended

Catalogue Number	Introducer	Dilator	Guide Wire 0.018" (0.46 mm) x 60 cm	Guide Wire Heavy Duty/Double Ended 0.038" (0.97 mm) 3mm J	Needle
MAK-NV-001	6F x 20 cm	4F	SS/PT	150 cm	21G x 15 cm Trocar
MAK-NV-002	6F x 20 cm	4F	NT/PT	150 cm	21G x 15 cm Trocar
MAK-NV-003	6F x 20 cm	4F	SS/PT	–	21G x 15 cm Trocar
MAK-NV-004	6F x 20 cm	4F	NT/PT	–	21G x 15 cm Trocar
MAK-NV-005*	–	–	–	–	21G x 15 cm Trocar
MAK-NV-006*	6F x 20 cm	4F	–	–	21G x 15 cm Trocar
MAK-NV-007*	6F x 20 cm	4F	–	–	–
MAK-NV-008	6F x 20 cm	4F	SS/PT	80 cm	21G x 15 cm Trocar
MAK-NV-009	6F x 20 cm	4F	NT/PT	80 cm	21G x 15 cm Trocar
MAK-NV-010	6F x 20 cm	4F	SS/PT	150 cm	21G x 15 cm Chiba
MAK-NV-011	6F x 20 cm	4F	NT/PT	150 cm	21G x 15 cm Chiba
MAK-NV-012	6F x 20 cm	4F	SS/PT	–	21G x 15 cm Chiba
MAK-NV-013	6F x 20 cm	4F	NT/PT	–	21G x 15 cm Chiba
MAK-NV-014*	–	–	–	–	21G x 15 cm Chiba
MAK-NV-015*	6F x 20 cm	4F	–	–	21G x 15 cm Chiba
MAK-NV-016	6F x 20 cm	4F	SS/PT	80 cm	21G x 15 cm Chiba
MAK-NV-017	6F x 20 cm	4F	NT/PT	80 cm	21G x 15 cm Chiba
MAK-NV-018	6F x 20 cm	4F	SS/PT	150 cm	21G x 20 cm Trocar
MAK-NV-019	6F x 20 cm	4F	NT/PT	150 cm	21G x 20 cm Trocar
MAK-NV-020*	–	–	–	–	21G x 20 cm Trocar
MAK-NV-021*	–	–	–	–	21G x 20 cm Chiba

SS = Stainless Steel PT = Platinum Tip NT = Nitinol

Packaged 10 per box.

*Packaged 5 per box.

VALVE ADAPTER FOR MAK-NV™ INTRODUCER SYSTEM

Designed to be back-loaded over a guide wire and attached to the MAK-NV Introducer System to facilitate aspiration or infusion. Will accept devices up to 4F. Packaged 10 per box.

Catalogue Number VA-40

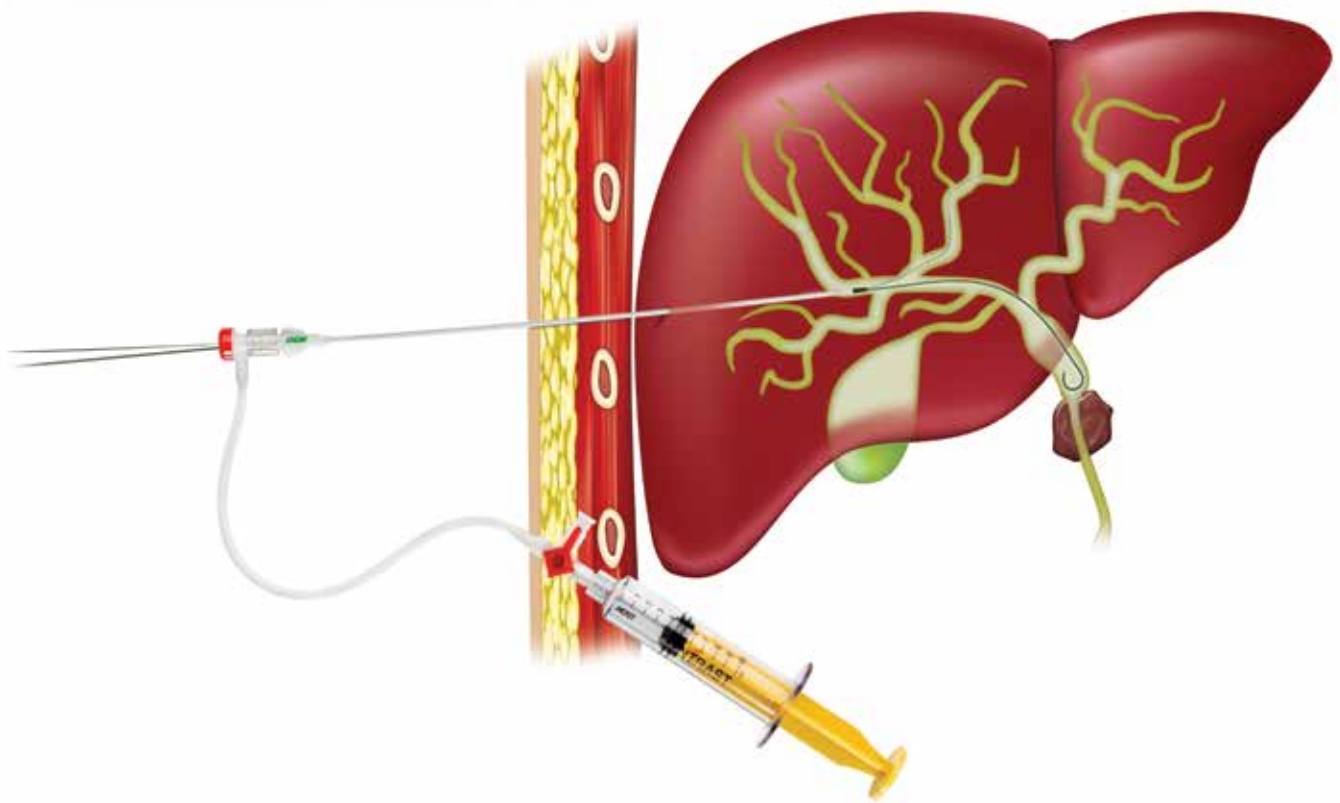
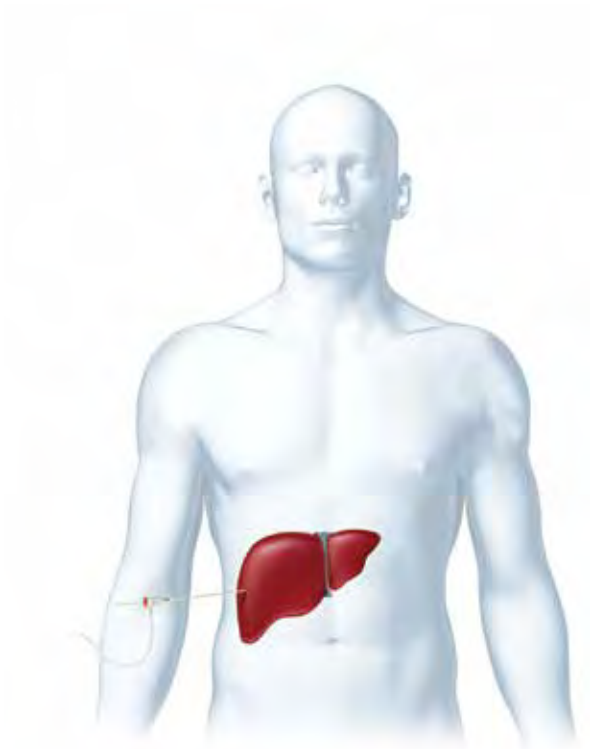

RESOLVE® BILIARY LOCKING DRAINAGE CATHETERS

The Resolve® Biliary Catheter's polyurethane material allows for long-term indwelling time; large drainage holes help maximise unimpeded drainage. Depth markers and radiopaque marker band help with fast and accurate positioning. Pigtail straightener allows for easy insertion of the stiffening cannula. Hydrophilic coating facilitates smooth insertion. Packaged 5 per box.

Catalogue Number	French Size	Drainage Location	Pigtail to Distal Shaft Drainage Hole	Drainage Holes
RBC-8-038	8.5	14 cm	5 cm	17
RBC-10-038	10	14 cm	5 cm	17
RBC-12-038	12	14 cm	5 cm	18
RBC-14-038	14	14 cm	5 cm	18
RBDC-8-038	8.5	11 cm	2 cm	17
RBDC-10-038	10	11 cm	2 cm	17
RBDC-12-038	12	11 cm	2 cm	18
RBDC-14-038	14	11 cm	2 cm	18

WITH REVOLUTION™ CATHETER SECUREMENT DEVICE

RBC-8-REV	8.5	14 cm	5 cm	17
RBC-10-REV	10	14 cm	5 cm	17
RBC-12-REV	12	14 cm	5 cm	18
RBC-14-REV	14	14 cm	5 cm	18
RBDC-8-REV	8.5	11 cm	2 cm	17
RBDC-10-REV	10	11 cm	2 cm	17
RBDC-12-REV	12	11 cm	2 cm	18
RBDC-14-REV	14	11 cm	2 cm	18

WITH STAYFIX® FIXATION DEVICE

RBC-8-SFX	8.5	14 cm	5 cm	17
RBC-10-SFX	10	14 cm	5 cm	17
RBC-12-SFX	12	14 cm	5 cm	18
RBC-14-SFX	14	14 cm	5 cm	18
RBDC-8-SFX	8.5	11 cm	2 cm	17
RBDC-10-SFX	10	11 cm	2 cm	17
RBDC-12-SFX	12	11 cm	2 cm	18
RBDC-14-SFX	14	11 cm	2 cm	18



Components:

- ReSolve Biliary Locking Drainage Catheter
- Metal Stiffening Cannula
- Flexible Stiffening Cannula
- Repositioning Tool

RESOLVE® LOCKING DRAINAGE CATHETERS

The ReResolve Locking Drainage Catheters have a hydrophilic coating and tapered tip for smooth insertion. Maximum drainage is achieved via the large drainage holes. Features manual release with or without marker band. Packaged 5 per box.

Components:

- ReResolve Locking Catheter
- Metal Stiffening Cannula
- Trocar Stylet
- Plastic Stiffening Cannula (not included with 6.5F or 7.5F catheters)
- Repositioning Tool

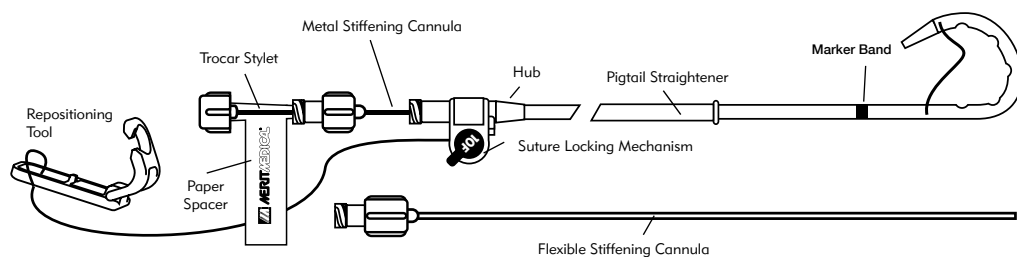

Catalogue Number	French Size	Catheter Length	Accepts Guide Wire	Drainage Holes	Marker Band	Tip Configuration
RLC-6-038	6.5	25 cm	0.038" (0.97 mm)	8	-	pigtail
RLC-7-038	7.5	25 cm	0.038" (0.97 mm)	8	-	pigtail
RLC-8-038	8.5	25 cm	0.038" (0.97 mm)	8	-	pigtail
RLC-10-038	10	25 cm	0.038" (0.97 mm)	8	-	pigtail
RLC-12-038	12	25 cm	0.038" (0.97 mm)	9	-	pigtail
RLC-14-038	14	25 cm	0.038" (0.97 mm)	9	-	pigtail
RLC15-6-038MB	6.5	15 cm	0.038" (0.97 mm)	8	yes	pigtail
RLC15-7-038MB	7.5	15 cm	0.038" (0.97 mm)	8	yes	pigtail
RLC15-8-038MB	8.5	15 cm	0.038" (0.97 mm)	8	yes	pigtail
RLC15-10-038MB	10	15 cm	0.038" (0.97 mm)	8	yes	pigtail
RLC15-12-038MB	12	15 cm	0.038" (0.97 mm)	9	yes	pigtail
RLC15-14-038MB	14	15 cm	0.038" (0.97 mm)	9	yes	pigtail
RLC-6-038MB	6.5	25 cm	0.038" (0.97 mm)	8	yes	pigtail
RLC-7-038MB	7.5	25 cm	0.038" (0.97 mm)	8	yes	pigtail
RLC-8-038MB	8.5	25 cm	0.038" (0.97 mm)	8	yes	pigtail
RLC-10-038MB	10	25 cm	0.038" (0.97 mm)	8	yes	pigtail
RLC-12-038MB	12	25 cm	0.038" (0.97 mm)	9	yes	pigtail
RLC-14-038MB	14	25 cm	0.038" (0.97 mm)	9	yes	pigtail
RLC40-6-038MB	6.5	40 cm	0.038" (0.97 mm)	8	yes	pigtail
RLC40-7-038MB	7.5	40 cm	0.038" (0.97 mm)	8	yes	pigtail
RLC40-8-038MB	8.5	40 cm	0.038" (0.97 mm)	8	yes	pigtail
RLC40-10-038MB	10	40 cm	0.038" (0.97 mm)	8	yes	pigtail
RLC40-12-038MB	12	40 cm	0.038" (0.97 mm)	9	yes	pigtail
RLC40-14-038MB	14	40 cm	0.038" (0.97 mm)	9	yes	pigtail



RESOLVE+™ LOCKING DRAINAGE CATHETERS

The ReSolve+ Locking Drainage Catheter provides the convenience of having the ReSolve Locking Drainage Catheter packaged with either the Revolution™ or StayFIX® catheter fixation devices. Packaged 5 per box.

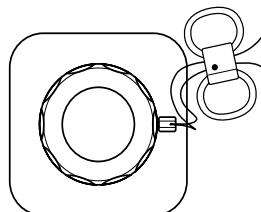
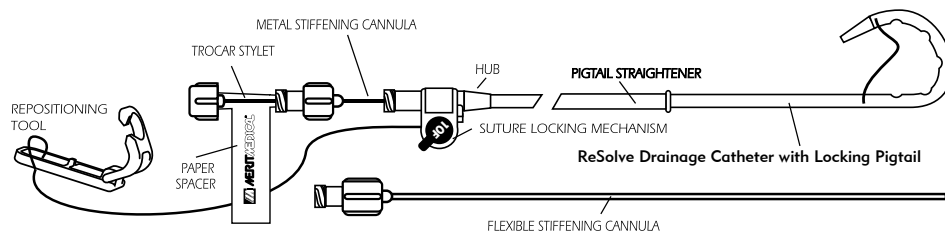

Revolution

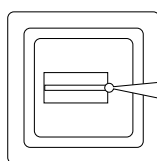

StayFIX Small

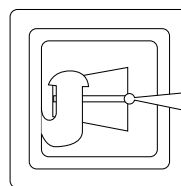

StayFIX Large

Catalogue Number	French Size	Marker Band	Catheter Fixation Device
RLC-6-REV	6.5	no	Revolution
RLCMB-6-REV	6.5	yes	Revolution
RLC-7-REV	7.5	no	Revolution
RLCMB-7-REV	7.5	yes	Revolution
RLC-8-REV	8.5	no	Revolution
RLCMB-8-REV	8.5	yes	Revolution
RLC-10-REV	10	no	Revolution
RLCMB-10-REV	10	yes	Revolution
RLC-12-REV	12	no	Revolution
RLCMB-12-REV	12	yes	Revolution
RLC-14-REV	14	no	Revolution
RLCMB-14-REV	14	yes	Revolution
RLC-6-SFX	6.5	no	StayFIX (small)
RLCMB-6-SFX	6.5	yes	StayFIX (small)
RLC-7-SFX	7.5	no	StayFIX (small)
RLCMB-7-SFX	7.5	yes	StayFIX (small)
RLC-8-SFX	8.5	no	StayFIX (small)
RLCMB-8-SFX	8.5	yes	StayFIX (small)
RLC-10-SFX	10	no	StayFIX (small)
RLCMB-10-SFX	10	yes	StayFIX (small)
RLC-12-SFX	12	no	StayFIX (small)
RLCMB-12-SFX	12	yes	StayFIX (small)
RLC-14-SFX	14	no	StayFIX (large)
RLCMB-14-SFX	14	yes	StayFIX (large)

RESOLVE® LOCKING DRAINAGE CATHETER TRAYS

The trays conveniently contain the ReSolve Locking Drainage Catheter, MAK-NV™ introducer system, Merit Drainage Depot™ drainage bag, and dilators.

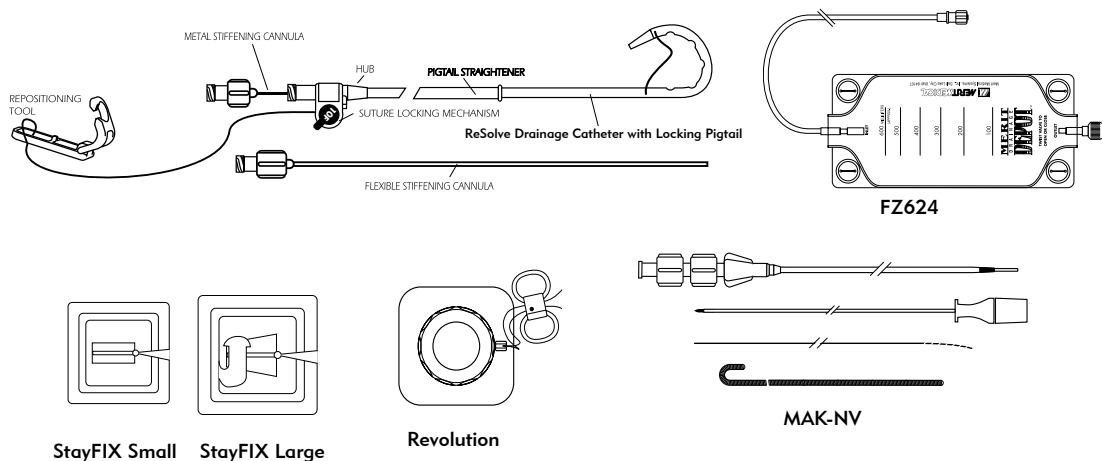

Catalogue Number	French Size	20 cm Dilator French Size	Marker Band	Securement Device
RLC-NV-6	6.5	-	no	-
RLC-NV-8	8.5	8F	no	-
RLC-NV-10	10	8F, 10F	no	-
RLC-NV-12	12	8F, 10F, 12F	no	-
RLC-NV-14	14	8F, 10F, 12F, 14F	no	-
RLCMB-NV-6	6.5	-	yes	-
RLCMB-NV-8	8.5	8F	yes	-
RLCMB-NV-10	10	8F, 10F	yes	-
RLCMB-NV-12	12	8F, 10F, 12F	yes	-
RLCMB-NV-14	14	8F, 10F, 12F, 14F	yes	-
RLC-NV-6-REV	6.5	-	no	Revolution
RLC-NV-8-REV	8.5	8F	no	Revolution
RLC-NV-10-REV	10	8F, 10F	no	Revolution
RLC-NV-12-REV	12	8F, 10F, 12F	no	Revolution
RLC-NV-14-REV	14	8F, 10F, 12F, 14F	no	Revolution
RLCMB-NV-6-REV	6.5	-	yes	Revolution
RLCMB-NV-8-REV	8.5	8F	yes	Revolution
RLCMB-NV-10-REV	10	8F, 10F	yes	Revolution
RLCMB-NV-12-REV	12	8F, 10F, 12F	yes	Revolution
RLCMB-NV-14-REV	14	8F, 10F, 12F, 14F	yes	Revolution
RLC-NV-6-SFX	6.5	-	no	StayFIX (small)
RLC-NV-8-SFX	8.5	8F	no	StayFIX (small)
RLC-NV-10-SFX	10	8F, 10F	no	StayFIX (small)
RLC-NV-12-SFX	12	8F, 10F, 12F	no	StayFIX (small)
RLC-NV-14-SFX	14	8F, 10F, 12F, 14F	no	StayFIX (large)
RLCMB-NV-6-SFX	6.5	-	yes	StayFIX (small)
RLCMB-NV-8-SFX	8.5	8F	yes	StayFIX (small)
RLCMB-NV-10-SFX	10	8F, 10F	yes	StayFIX (small)
RLCMB-NV-12-SFX	12	8F, 10F, 12F	yes	StayFIX (small)
RLCMB-NV-14-SFX	14	8F, 10F, 12F, 14F	yes	StayFIX (large)

RESOLVE® NON-LOCKING DRAINAGE CATHETERS

For a smooth insertion, ReSolve catheters have a tapered tip and hydrophilic coating. Maximum drainage is achieved via the large drainage holes. Packaged individually with catheter, metal stiffening cannula and trocar stylet. Packaged 5 per box.



Catalogue Number	French Size	Catheter Length	Accepts Guide Wire	Drainage Holes	Tip Configuration
RNL-6-038S	6.5	20 cm	0.038" (0.97 mm)	4	straight
RNL-7-038S	7.5	25 cm	0.038" (0.97 mm)	4	straight
RNL-8-038S	8.5	25 cm	0.038" (0.97 mm)	4	straight
RNL-10-038S	10	25 cm	0.038" (0.97 mm)	4	straight
RNL-12-038S	12	25 cm	0.038" (0.97 mm)	5	straight
RNL-6-038J	6.5	20 cm	0.038" (0.97 mm)	4	J curve
RNL-7-038J	7.5	25 cm	0.038" (0.97 mm)	4	J curve
RNL-8-038J	8.5	25 cm	0.038" (0.97 mm)	4	J curve
RNL-10-038J	10	25 cm	0.038" (0.97 mm)	4	J curve
RNL-12-038J	12	25 cm	0.038" (0.97 mm)	5	J curve

ONE-STEP™ CENTESIS CATHETERS

The Valved One-Step has been designed to improve the comfort, efficiency, and safety of your aspiration, paracentesis, and thoracentesis procedures. The self-closing valve reduces the risk of pneumothorax and fluid leakage. The low profile, tapered tip and smooth transitions help decrease resistance and patient discomfort. An echo-enhanced needle ensures more accurate placement and four large drainage holes spiral around the catheter for more effective drainage. Available valved and non-valved. Packaged 5 units per box.



The Valved One-Step Centesis Catheter is designed with an integrated self-sealing valve to minimise the risk of air entering the pleural space.

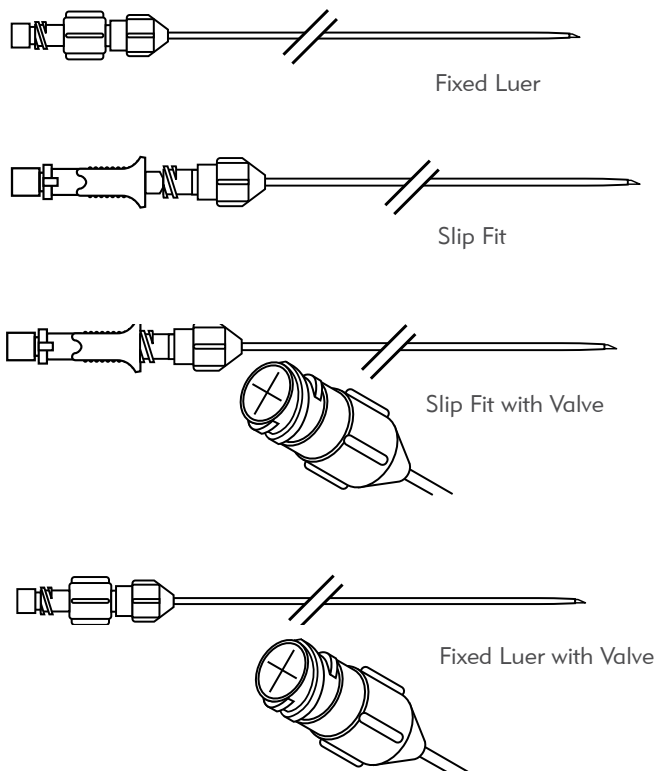

OSC-4F-7L OSC-5F-7T

4F WITH 20G INTRODUCER NEEDLE

Catalogue Number	4F 7 cm	4F 10 cm	Description
	OSC-4F-7L	OSC-4F-10L	Fixed Luer
	OSC-4F-7LNH	OSC-4F-10LNH	Fixed Luer no side holes
	OSC-4F-7S	OSC-4F-10S	Slip Fit
	OSC-4F-7T	OSC-4F-10T	Slip Fit with valve
	OSC-4F-7LT	OSC-4F-10LT	Fixed Luer with valve

5F WITH 19G INTRODUCER NEEDLE

Catalogue Number	5F 7 cm	5F 10 cm	5F 15 cm	Description
	OSC-5F-7L	OSC-5F-10L	OSC-5F-15L	Fixed Luer
	OSC-5F-7LNH	OSC-5F-10LNH	OSC-5F-15LNH	Fixed Luer no side holes
	OSC-5F-7S	OSC-5F-10S	OSC-5F-15S	Slip Fit
	OSC-5F-7T	OSC-5F-10T	OSC-5F-15T	Slip Fit with valve
	OSC-5F-7LT	OSC-5F-10LT	OSC-5F-15LT	Fixed Luer with valve

SAFETY PARACENTESIS PROCEDURE TRAY

The Safety Paracentesis Procedure Tray is designed to fulfill clinical needs safely, easily, and in a time-saving way. The tray comes with or without a One-Step™ Centesis Catheter, as well as necessary products to complete a paracentesis procedure and contains three safety needles to ensure a safe working environment.

Quantity Description:

1	One-Step centesis catheter (not included in SPPT-100)
1	Fenestrated Drape with Adhesive Backing
1	Drape Tri Layer (18" x 26")
1	20 mL Lidocaine HCl Injection USP 1%
1	18G x 1" (25.4 mm) Shielded Needle
1	25G x 1" (25.4 mm) Shielded Needle
1	22G x 1.5" (38.1 mm) Shielded Needle
1	10 mL Luer Lock Syringe
10	Gauze Pads 4" x 4" (10 cm x 10 cm)
1	#11 Futura® Safety Scalpel
1	60 mL Luer Lock Syringe
2	Specimen Vials (10 mL)
1	Non-vented Universal Cap
1	Large Bore Stopcock (3-way)
1	Tubing set, 48" (122 cm) (with Pinch Clamp & Non-vented Spike)
1	Bandage Dressing (1"x3")
1	Kimguard wrap
1	10 mL Medallion® Syringe
1	3 mL ChloraPrep® brand tinted Lidocaine Label



Packaged 5 per box.

Catalogue Number	Catheter Included	Length	Description
SPPT-100	-	-	without a centesis catheter
SPPT-5F-7L	5F	7 cm	fixed Luer
SPPT-5F-10L	5F	10 cm	fixed Luer
SPPT-5F-7S	5F	7 cm	slip fit
SPPT-5F-10S	5F	10 cm	slip fit

Safety Paracentesis Procedure Trays do not have CE Marking.
ChloraPrep® is a registered trademark of CareFusion 2200, Inc.

THORACENTESIS AND PARACENTESIS SET

The Thoracentesis and Paracentesis Set from Merit Medical combines all the necessary components for centesis procedures in a convenient all-in-one set. Set includes the low-profile Valved One-Step™ Centesis Catheter and the components needed for drainage of fluid and specimen collection for diagnostic purposes. Merit Medical's Valved One-Step Centesis Catheter is designed with an integrated self-sealing valve to minimise the risk of air entering the pleural space and to prevent fluid leakage during thoracentesis and paracentesis.

Quantity Description:

1	Valved One-Step™ Centesis Catheter (not included in TAPS-100)
1	Fenestrated Drape with Adhesive Backing
1	Drape Tri Layer (18" x 26")
1	20 mL Lidocaine HCl Injection USP 1%
1	18G x 1" (25.4 mm) Shielded Needle
1	25G x 1" (25.4 mm) Shielded Needle
1	22G x 1.5" (38.1 mm) Shielded Needle
1	10 mL Luer Lock Syringe
10	Gauze Pads 4" x 4" (10 cm x 10 cm)
1	#11 Futura® Safety Scalpel
1	60 mL Luer Lock Syringe
2	Specimen Vials (10 mL)
1	Non-vented Female Cap
1	Large Bore Stopcock (3-way)
1	Tubing set, 48" (122 cm) (with Pinch Clamp & Non-vented Spike)
1	Tubing Set, 48" (122 cm) (with Roller Clamp & 16G X 1.5" needle)
1	Bandage Dressing (1"x 3")
1	CSR wrap
1	10 mL Medallion® Syringe
1	3 mL ChloraPrep® brand tinted
1	Lidocaine Label

Packaged 5 per box.

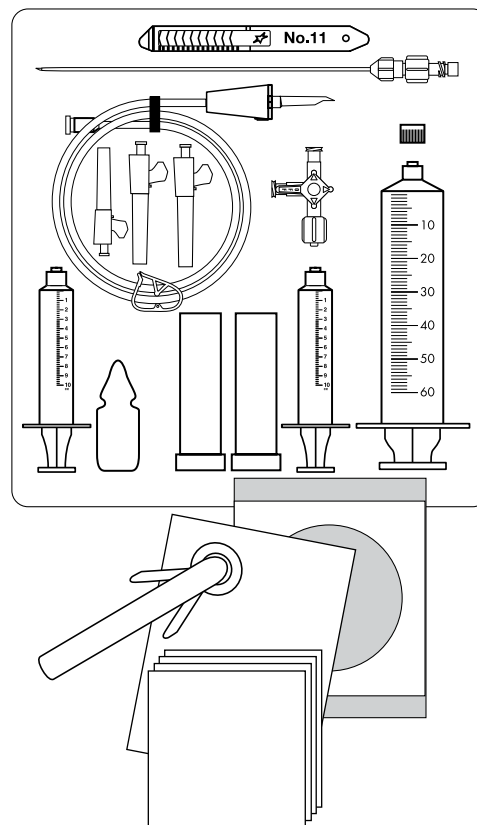

Catalogue Number	Catheter Included	Length	Description
TAPS-100	-	-	without a centesis catheter
TAPS-5F-7LT	5	7 cm	fixed Luer
TAPS-5F-10LT	5	10 cm	fixed Luer
TAPS-5F-7T	5	7 cm	slip fit
TAPS-5F-10T	5	10 cm	slip fit

Thoracentesis and Paracentesis Sets do not have CE Marking.
ChloraPrep® is a registered trademark of CareFusion 2200, Inc.

REVOLUTION™ CATHETER SECUREMENT DEVICE

The Revolution catheter securement device provides safe and secure fixation for up to seven days. Its efficient needleless design saves time (requires only four steps for securement) and provides an unobstructed view of the catheter site. Includes cap for added protection while showering.

Catalogue Number CFG624

Packaged 25 units per box.



STAYFIX® FIXATION DEVICE

The StayFIX fixation device is a cost-effective, time-saving, needleless device designed to stop migration, movement, and accidental removal of a percutaneous catheter.

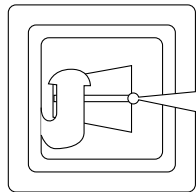
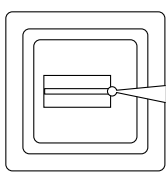

Catalogue Number	Product Size	Catheter Or Tube Size	Quantity Per Box
680ME	SMALL	5F - 14F	25
685ME	LARGE	12F - 22F	20

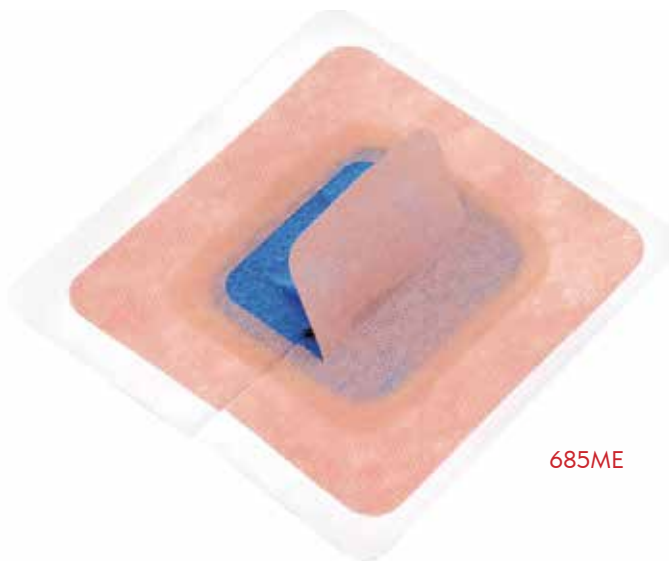

685ME

MERIT DRAINAGE DEPOT™ DRAINAGE BAGS

The Merit Drainage Depot drainage bags have easy-to-read markings to identify fluid volume, a twist valve for easy disposal of fluids, and an internal anti-reflux valve. Available with adjustable length tubing and a VELCRO® brand leg strap to fit a variety of patient sizes. Packaged 20 units per box, 4 boxes per case.



MDD600

Catalogue Number

MDD600	600 mL
FZ624	600 mL - with soft cloth backing

ABSCCESS DRAINAGE KIT

Includes 1400 mL Merit Drainage Depot drainage bag, tubing and check relief valve. Packaged 15 units per box, 4 boxes to case.

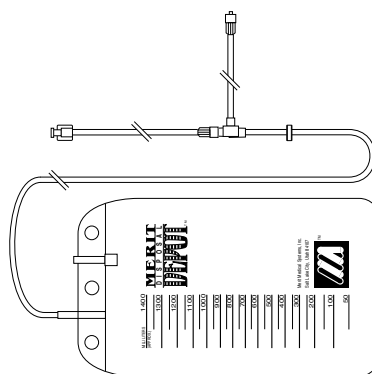

Catalogue Number

K10-00230B

DRAINAGE KITS

16" (41 cm) connection tube with barbed male Luer.

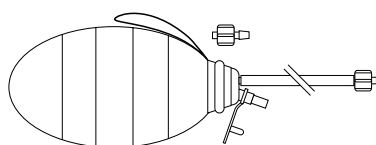

Jackson-Pratt®
100 mL bulb

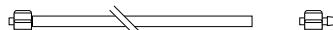

Tubing Kit with
Barbed Male Luer

Catalogue Number

K08-01907	Jackson-Pratt® 100 mL Bulb	Packaged 10 units per box, 4 boxes per case
K08-02027	Tubing Kit with Barbed Male Luer	Packaged 25 units per box, 4 boxes per case

DRAINAGE KIT

MDD600 Drainage Bag with Jackson-Pratt 100 mL Bulb, 12" (30.5 cm) connection tube with barbed male Luer, 24" (61 cm) kink-resistant tubing, VELCRO® brand fasteners strap and additional barbed male Luer connector. Packaged 10 units per box, 4 boxes per case.

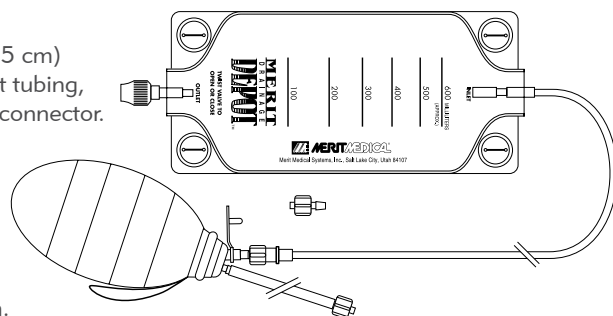

Catalogue Number K10-03450

Velcro® is a registered trademark of Velcro Industries B.V.
Jackson-Pratt® is a registered trademark of Allegiance Corporation.

VACLOK® VACUUM PRESSURE SYRINGES

The VacLok vacuum pressure syringe comes with a clear polycarbonate barrel, white plunger, four- or six-position locking mechanism and fixed male Luer. Packaged 20 or 25 units per box, 4 boxes per case.



10 mL
four position
25/box

20 mL
four position
20/box

30 mL
six position
20/box

60 mL
six position
25/box

Catalogue Number

K01-07736

K01-07738

K01-07739

K01-07740

MARQUIS® SERIES STOPCOCKS

Merit Medical's larger, easy-grip handle makes a Marquis stopcock effortless to grip and turn. The large bore stopcock with swivel nut Luer is available in 50 psi pressure rating. Packaged 50 units per box, 4 boxes per case.

Catalogue Number

L3SNC	50 psi	3-way
L4SNC	50 psi	4-way

More options available through Merit's Cardiac Intervention catalogue. Ask for more details.



L3SNC

DRAINAGE TUBING

Packaged 25 units per box, 4 boxes per case.

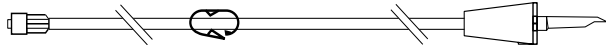

Catalogue Number

FAS5248	48" length (122 cm) large bore tubing set with non-vented spike
---------	---



FAS5248

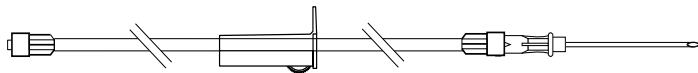

Catalogue Number

K10-04750	48" length (122 cm) large bore tubing set with 16G x 1.5" (38.1 mm) needle
-----------	--

CONNECTING TUBES

Packaged 25 units per box, 4 boxes per case.

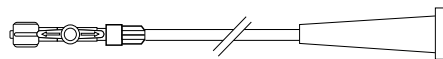
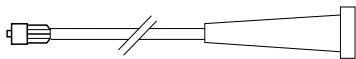

Catalogue Number

K10-04129	12" (30 cm)	K10-04131	12" (30 cm) with 1-way stopcock
K10-04130	16.5" (42 cm)	K10-04132	16.5" (42 cm) with 1-way stopcock

MERIT SURECROSS® SUPPORT CATHETERS

The Merit SureCross support catheter is engineered to optimise pushability and flexibility which maximises guide wire support, trackability, and lesion crossing. The SureCross has a translucent shaft for visualisation of blood to verify placement, three platinum marker bands to confirm position, 40 cm distal hydrophilic coating, and comes in multiple lengths.

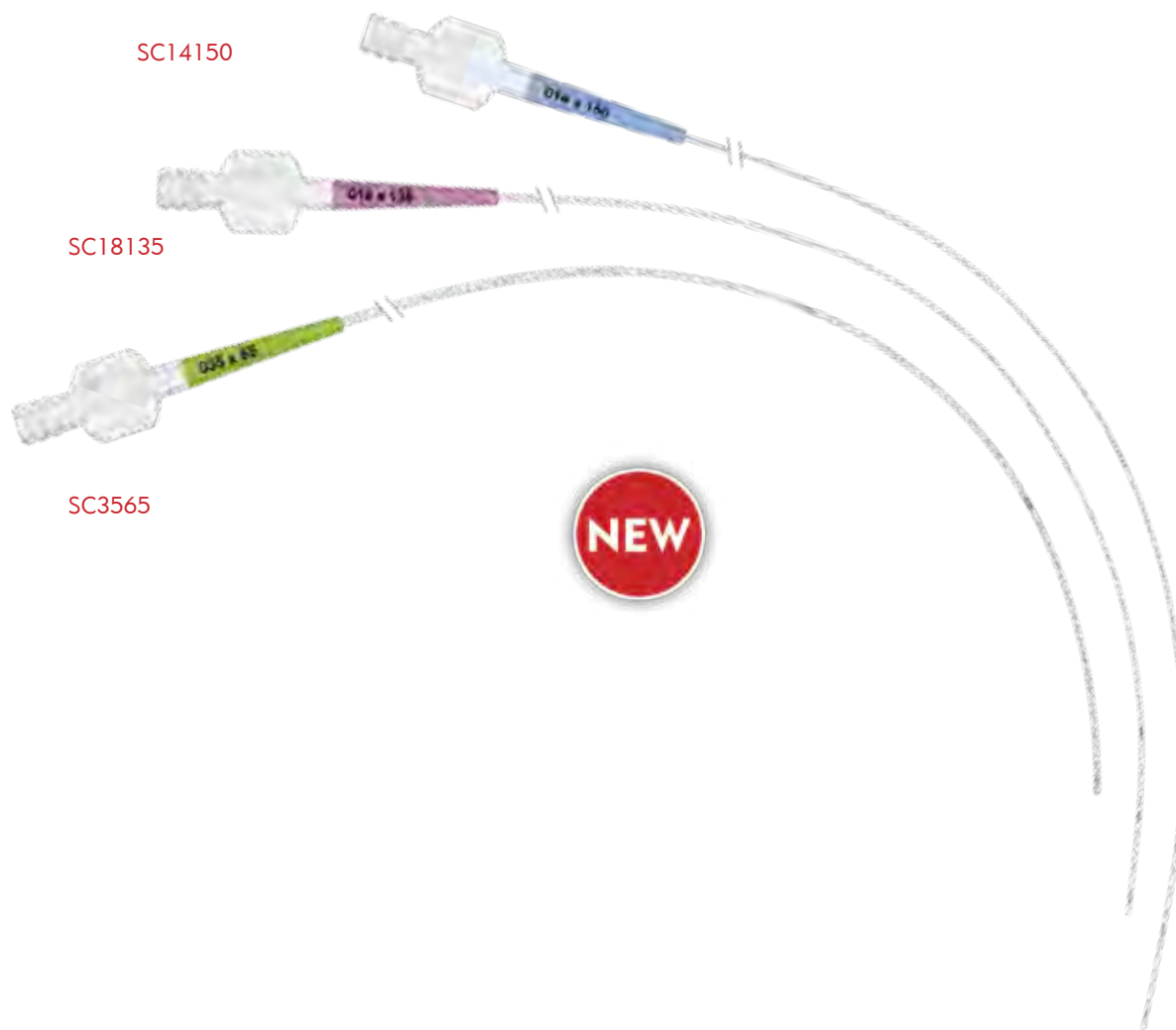

SC14150

SC18135

SC3565

NEW

Catalogue Number	Guide Wire Compatibility	Minimum Guiding Catheter	Minimum Sheath Introducer	Working Length	2nd & 3rd Marker Bands Spacing	Hydrophilic Coating Length	Strain Relief Colour	Crossing Profile
SC1465	0.014"	5F	4F	65 cm	15 mm	40 cm	Blue	1.5F (.020"/0.51 mm)
SC1490	0.014"	5F	4F	90 cm	5 mm	40 cm	Blue	1.5F (.020"/0.51 mm)
SC14135	0.014"	5F	4F	135 cm	15 mm	40 cm	Blue	1.5F (.020"/0.51 mm)
SC14150	0.014"	5F	4F	150 cm	15 mm	40 cm	Blue	1.5F (.020"/0.51 mm)
SC1865	0.018"	5F	4F	65 cm	15 mm	40 cm	Purple	1.7F (.022"/0.58 mm)
SC1890	0.018"	5F	4F	90 cm	15 mm	40 cm	Purple	1.7F (.022"/0.58 mm)
SC18135	0.018"	5F	4F	135 cm	15 mm	40 cm	Purple	1.7F (.022"/0.58 mm)
SC18150	0.018"	5F	4F	150 cm	15 mm	40 cm	Purple	1.7F (.022"/0.58 mm)
SC3565	0.035"	6F	5F	65 cm	50 mm	40 cm	Green	3.1F (.040"/1.04 mm)
SC3590	0.035"	6F	5F	90 cm	50 mm	40 cm	Green	3.1F (.040"/1.04 mm)
SC35135	0.035"	6F	5F	135 cm	50 mm	40 cm	Green	3.1F (.040"/1.04 mm)
SC35150	0.035"	6F	5F	150 cm	50 mm	40 cm	Green	3.1F (.040"/1.04 mm)

BowTie™ Guide Wire Insertion Device included in 0.014" and 0.018" configurations.
Packaged 5 per box.

BASIXCOMPAK™ INFLATION DEVICE

The BasixCOMPAK is a 30 atm analogue inflation device that features an angled gauge for better viewing of pressure readings and a luminescent dial for low-light procedures. The 5 mL of safety space is intended to minimise air bubbles introduced into the balloon. Includes 13" (33 cm) extension tubing and 3-way stopcock. Packaged 5 units per box, 4 boxes per case.

Catalogue Number IN4130



BASIXTOUCH™ INFLATION DEVICE

The BasixTOUCH inflation device is an innovative device with an ergonomic handle that enables one-handed preparation and priming, 35 atm pressure capability and 30 mL fluid capacity. Features a quick-release handle for easy release even from high-pressure inflations, accelerating deflation time. Reaches high pressures rapidly—with less than three rotations of the handle. Comes with high pressure stopcock. Packaged 5 per box.

Catalogue Number IN8130



BIG60® INFLATION DEVICE

The BIG60 inflation device is designed to rapidly inflate and deflate non-vascular balloon dilators while accurately monitoring and displaying crucial inflation pressures. The ergonomically designed 60 mL inflation device is a one-piece, easy-to-use disposable device that pairs Merit Medical's market-leading inflation device experience with our non-vascular stent technology.

Catalogue Number ENDO-AN6012



BLUE DIAMOND™ INFLATION DEVICE

The 30 atm Blue Diamond inflation device combines the accuracy of a digital device with the simplicity of analogue systems. Features include one-button functionality for simplicity, a large dial face with oversized digits to enhance visibility, and last inflation marks to recall the highest pressure of the previous inflation. Comes with 13" (33 cm) extension tubing and 3-way stopcock. Packaged 5 units per box, 4 boxes per case.

Catalogue Number IN7130



EN SNARE® ENDOVASCULAR SNARE SYSTEMS

The EN Snare Endovascular Snare System features three interlaced loops to retrieve and manipulate foreign objects in the body. The EN Snare is designed to rotate and expand for excellent coverage and retrieval within a variety of vessel sizes. Platinum strands are incorporated into the EN Snare loops for excellent visualisation under fluoroscopy.

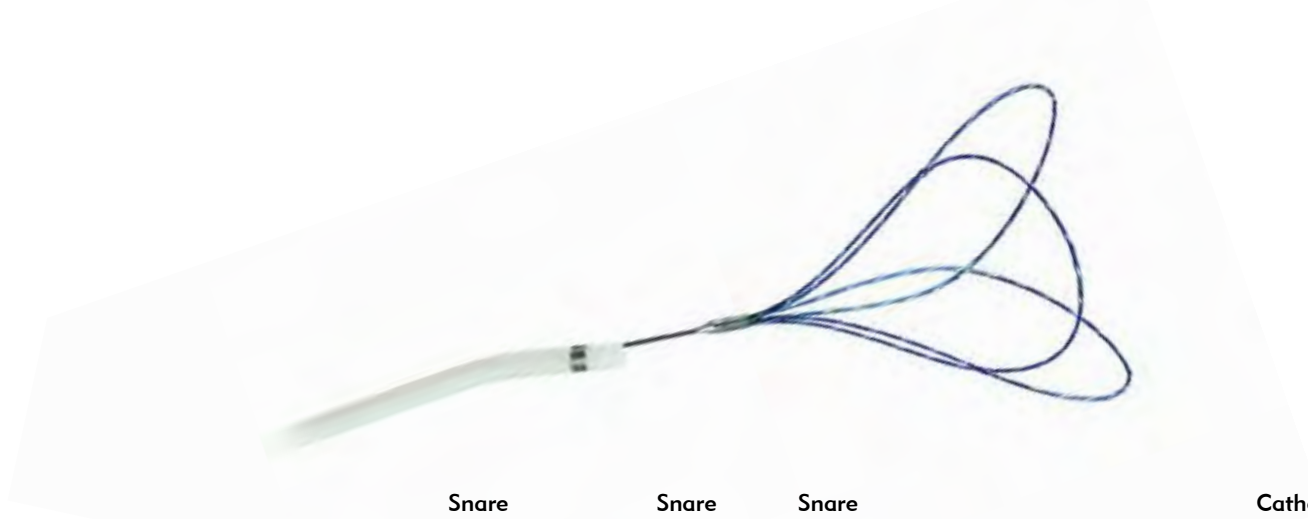

Catalogue Number	Snare Length	Snare Working Diameter	Snare Shaft Diameter	Snare Collapsed Diameter	Catheter Length	Catheter French Size	Catheter Inside Diameter
------------------	--------------	------------------------	----------------------	--------------------------	-----------------	----------------------	--------------------------

STANDARD SNARE KIT

EN2006010	120 cm	6 mm - 10 mm	0.66 mm	1.14 mm	100 cm	6F	1.58 mm
EN2006015	120 cm	9 mm - 15 mm	0.66 mm	1.40 mm	100 cm	6F	1.58 mm
EN2006020	120 cm	12 mm - 20 mm	0.66 mm	1.40 mm	100 cm	6F	1.58 mm
EN2007030	120 cm	18 mm - 30 mm	0.66 mm	1.40 mm	100 cm	7F	1.88 mm
EN2007045	120 cm	27 mm - 45 mm	0.66 mm	1.40 mm	100 cm	7F	1.88 mm

MINI SNARE KIT

EN1003004	175 cm	2 mm - 4 mm	0.46 mm	0.71 mm	150 cm	3.2F	0.76 mm
EN1003008	175 cm	4 mm - 8 mm	0.46 mm	0.71 mm	150 cm	3.2F	0.76 mm

Components:

- EN Snare
- Snare Delivery Catheter
- Torque Device
- Introducer

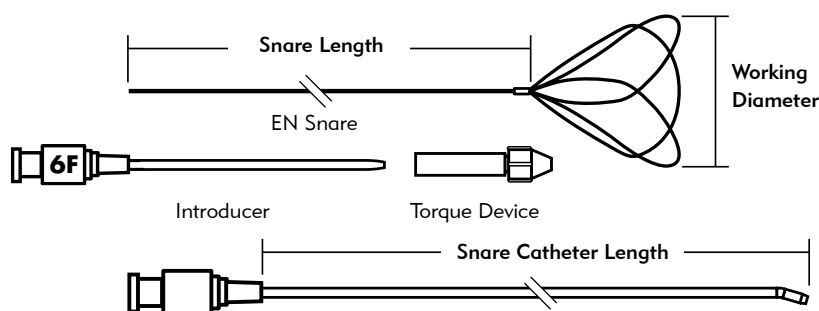

Snare systems sold individually.

FLO 30™ TUOHY BORST VALVED ADAPTER

Merit Medical's FLO 30 Tuohy Borst is a single-use, proprietary valved adapter which provides a leak-proof seal during interventional and diagnostic procedures. Packaged 25 units per box.



Catalogue

Number	Description
FLO30	FLO 30 Tuohy Borst Size: 9F

ONE SNARE® ENDOVASCULAR SNARE SYSTEMS

The ONE Snare Endovascular Snare System is a single-loop snare designed to provide both accuracy and reliability for effective foreign body manipulation and retrieval. Superelastic Nitinol provides flexibility and kink resistance. Gold-plated tungsten is wrapped around the Nitinol loop for excellent visualisation under fluoroscopy. The ONE Snare is available in multiple configurations to provide retrieval options within a variety of vessel sizes.



Catalogue Number	Snare Length	Snare Working Diameter	Snare Shaft Diameter	Snare Collapsed Diameter	Catheter Length	Catheter French Size	Catheter Inside Diameter
------------------	--------------	------------------------	----------------------	--------------------------	-----------------	----------------------	--------------------------

STANDARD SNARE KIT

ONE500	120 cm	5 mm	0.81 mm	–	100 cm	4F	1.02 mm
ONE1000	120 cm	10 mm	0.81 mm	–	100 cm	4F	1.02 mm
ONE1500	120 cm	15 mm	0.89 mm	–	100 cm	6F	1.42 mm
ONE2000	120 cm	20 mm	0.89 mm	–	100 cm	6F	1.42 mm
ONE2500	120 cm	25 mm	0.89 mm	–	100 cm	6F	1.42 mm
ONE3000	120 cm	30 mm	0.89 mm	–	100 cm	6F	1.42 mm
ONE3500	120 cm	35 mm	0.89 mm	–	100 cm	6F	1.42 mm

PETITE SNARE KIT

ONE1001	65 cm	10 mm	0.81 mm	–	48 cm	4F	1.02 mm
ONE2501	65 cm	25 mm	0.89 mm	–	48 cm	6F	1.42 mm

MICROSNARE KIT

ONE200	175 cm	2 mm	0.41 mm	–	150 cm	2.3-3F	0.48 mm
ONE201	200 cm	2 mm	0.41 mm	–	175 cm	2.3-3F	0.48 mm
ONE400	175 cm	4 mm	0.41 mm	–	150 cm	2.3-3F	0.48 mm
ONE401	200 cm	4 mm	0.41 mm	–	175 cm	2.3-3F	0.48 mm
ONE700	175 cm	7 mm	0.41 mm	–	150 cm	2.3-3F	0.48 mm
ONE701	200 cm	7 mm	0.41 mm	–	175 cm	2.3-3F	0.48 mm

CATHETER REPLACEMENTS

ONE4000	–	–	–	–	100 cm	4F	1.02 mm
ONE6000	–	–	–	–	100 cm	6F	1.42 mm

Components:

- ONE Snare
- Snare Delivery Catheter
- Torque Device
- Introducer

Snare systems sold individually.

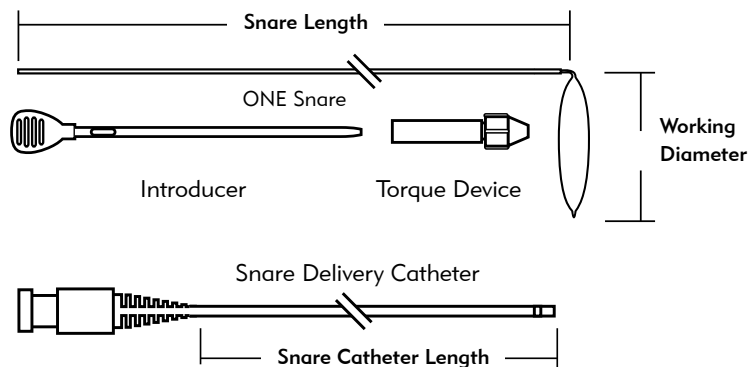

MERIT ADVANCE® CURVED NEEDLES

The Merit Advance Curved needle is used to aid clinicians who want to place a tunneled dialysis catheter over a wire with a single stick.

Catalogue Number	Gauge	Wall Thickness	Accepts Guide Wire	Length (cm)	Length (Inch)	Finish
AD21T91R	21	Thin	0.021" (0.53 mm)	9	3.5	Smooth
AD21T91RE	21	Thin	0.021" (0.53 mm)	9	3.5	Echo

Packaged 10 per box, 4 boxes per case.

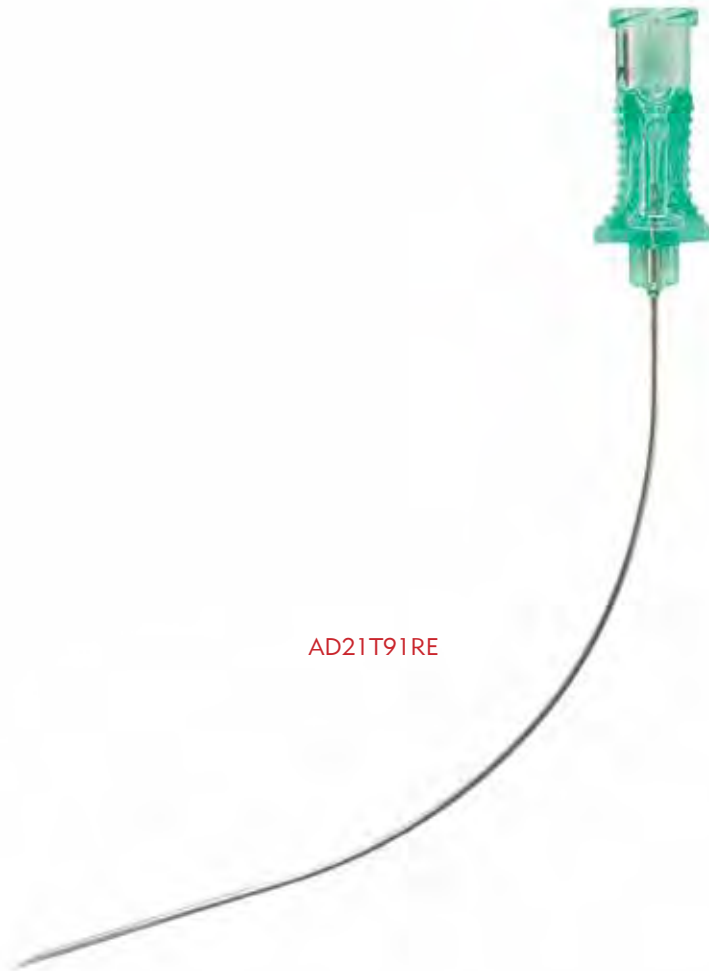

PRELUDE® SHORT SHEATH INTRODUCERS

The Prelude Short Sheath Introducer provides access to dialysis fistulas and grafts. Can be used for declot, angioplasty, and thrombolysis procedures, as well as temporary haemodialysis. Will accommodate flow rates up to 600 mL/min. Includes removable stopcock.

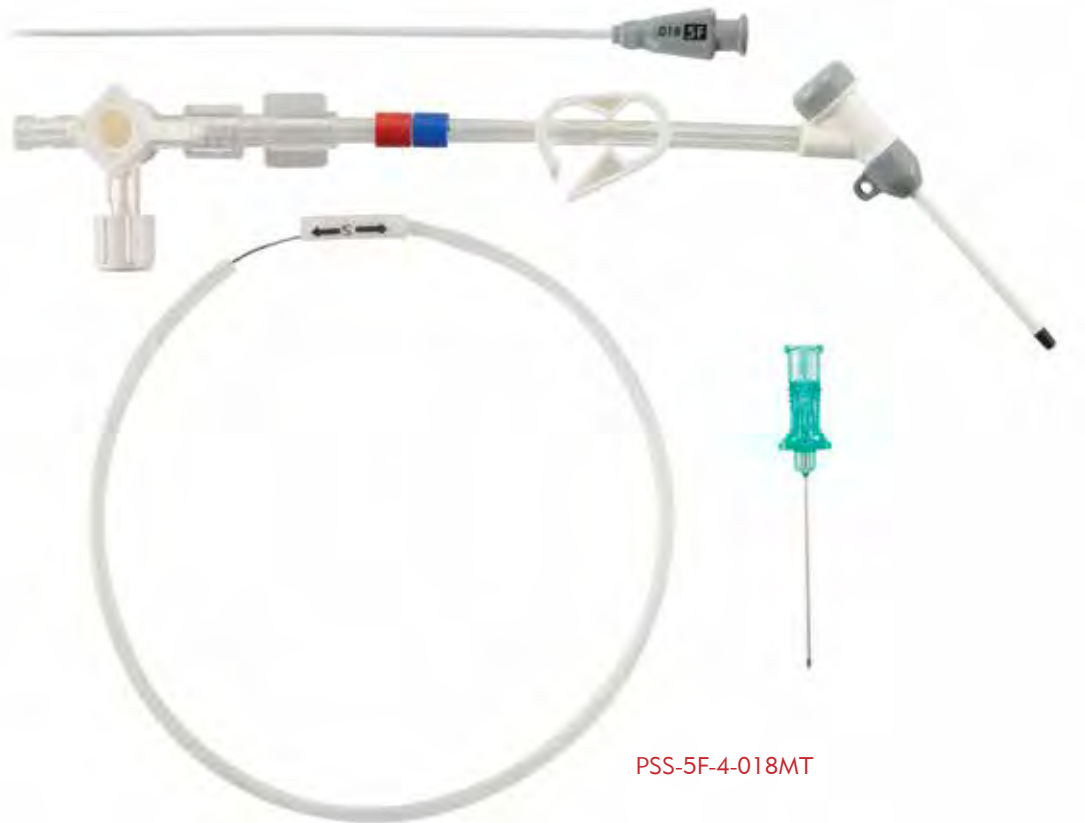

PSS-5F-4-018MT

Catalogue Number	French Size	Length	Guide Wire Diameter/Length	Needle Gauge/Length	Hub Colour	Qty/box
PSS-5F-4-018MT*	5	4 cm	0.018" (0.46 mm) x 40 cm	21G x 4 cm	gray	5
PSS-6F-4-018MT	6	4 cm	0.018" (0.46 mm) x 40 cm	21G x 4 cm	green	5
PSS-7F-4-018MT	7	4 cm	0.018" (0.46 mm) x 40 cm	21G x 4 cm	orange	5
PSS-8F-4-018MT	8	4 cm	0.018" (0.46 mm) x 40 cm	21G x 4 cm	blue	5
PSS-5F-4-035MT**	5	4 cm	0.035" (0.89 mm) x 50 cm	–	gray	5
PSS-6F-4-035MT	6	4 cm	0.035" (0.89 mm) x 50 cm	–	green	5
PSS-7F-4-035MT	7	4 cm	0.035" (0.89 mm) x 50 cm	–	orange	5
PSS-8F-4-035MT	8	4 cm	0.035" (0.89 mm) x 50 cm	–	blue	5
PSS-5F-4-038MT**	5	4 cm	0.038" (0.97 mm) x 50 cm	–	gray	5
PSS-6F-4-038MT	6	4 cm	0.038" (0.97 mm) x 50 cm	–	green	5
PSS-7F-4-038MT	7	4 cm	0.038" (0.97 mm) x 50 cm	–	orange	5
PSS-8F-4-038MT	8	4 cm	0.038" (0.97 mm) x 50 cm	–	blue	5
PSS-5F-4MT	5	4 cm	N/A	–	gray	5
PSS-6F-4MT	6	4 cm	N/A	–	green	5
PSS-7F-4MT	7	4 cm	N/A	–	orange	5
PSS-8F-4MT	8	4 cm	N/A	–	blue	5

* 0.018" Guide wire is stainless steel with straight stainless steel flexible tip.

** 0.035" and 0.038" Guide wires are stainless steel; double ended (3 mm J and floppy).

IMPRESS® 30 CM CATHETERS

Shorter catheter lengths enable the clinician to be closer to the working site on the forearm while providing excellent torque. Impress catheters feature tapered tips to minimise vessel trauma, accordion hubs to minimise kinking, and a proprietary braid pattern shaft to provide maximum flexibility without compromising steerability. Packaged 5 units per box.

Catalogue Number	French Size	Internal Diameter	Length	# of Side Ports	Description	Recommended Guide Wire
43035MODCB1	4	.040"/1.02 mm	30 cm	-		0.035" (0.089 mm)
43035BER	4	.040"/1.02 mm	30 cm	-		0.035" (0.089 mm)
43035KA2	4	.040"/1.02 mm	30 cm	-		0.035" (0.089 mm)
43035STR	4	.040"/1.02 mm	30 cm	-		0.035" (0.089 mm)
43035RIM	4	.040"/1.02 mm	30 cm	-		0.035" (0.089 mm)
4303510PIG-NB	4	.040"/1.02 mm	30 cm	10	non-braided	0.035" (0.089 mm)
53035MODCB1	5	.046"/1.17 mm	30 cm	-		0.035" (0.089 mm)
53035BER	5	.046"/1.17 mm	30 cm	-		0.035" (0.089 mm)
53035KA2	5	.046"/1.17 mm	30 cm	-		0.035" (0.089 mm)
53035STR	5	.046"/1.17 mm	30 cm	-		0.035" (0.089 mm)
53035RIM	5	.046"/1.17 mm	30 cm	-		0.035" (0.089 mm)
5303510PIG-NB	5	.049"/1.25 mm	30 cm	10	non-braided	0.035" (0.089 mm)

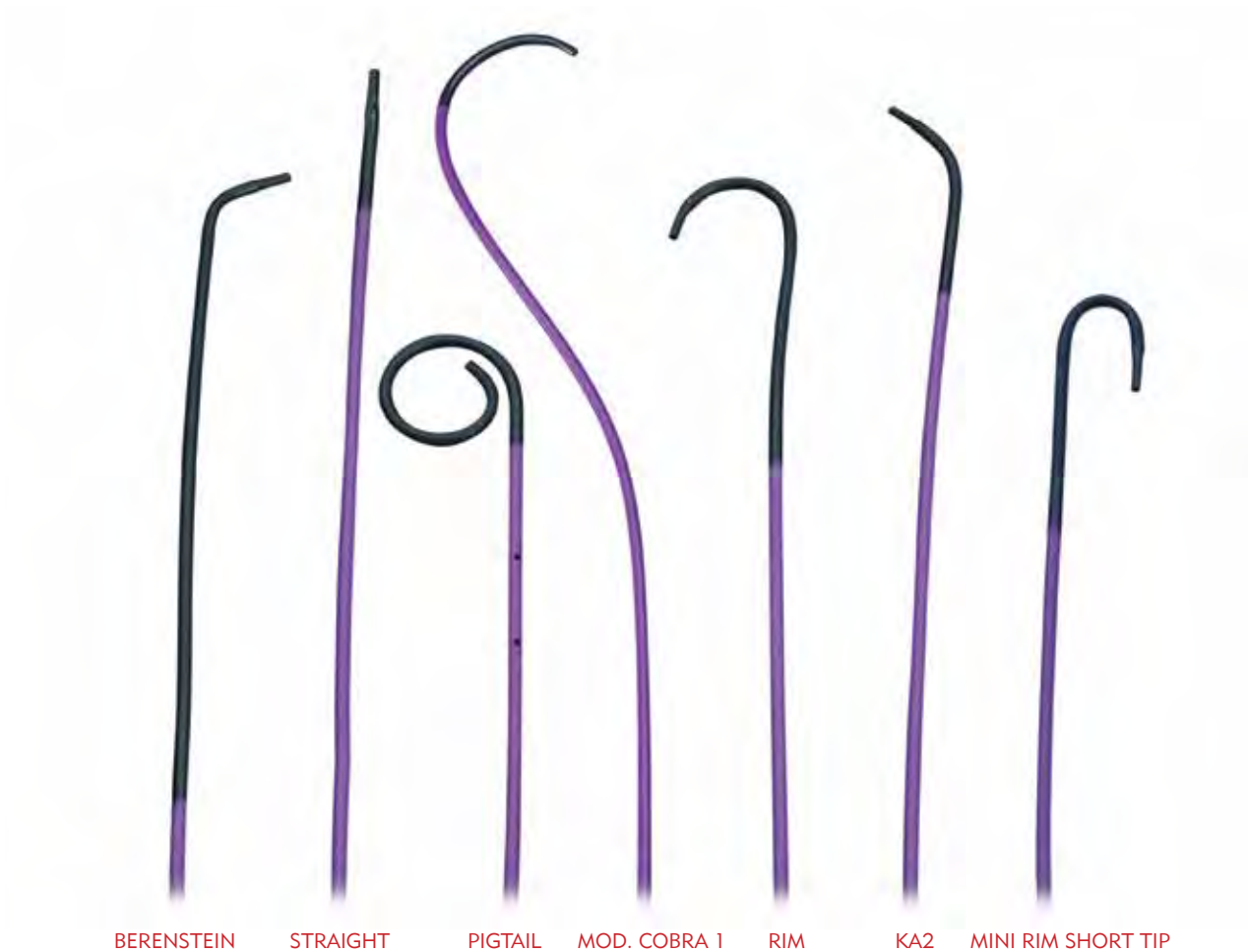

INTERVENTION

CENTROS® & CENTROSFLO® CATHETERS

The highly innovative catheter design features preformed curved tips which automatically center the catheter ports within the middle of the vessel to maintain optimal blood flow and minimal recirculation rates, enhancing overall catheter performance.

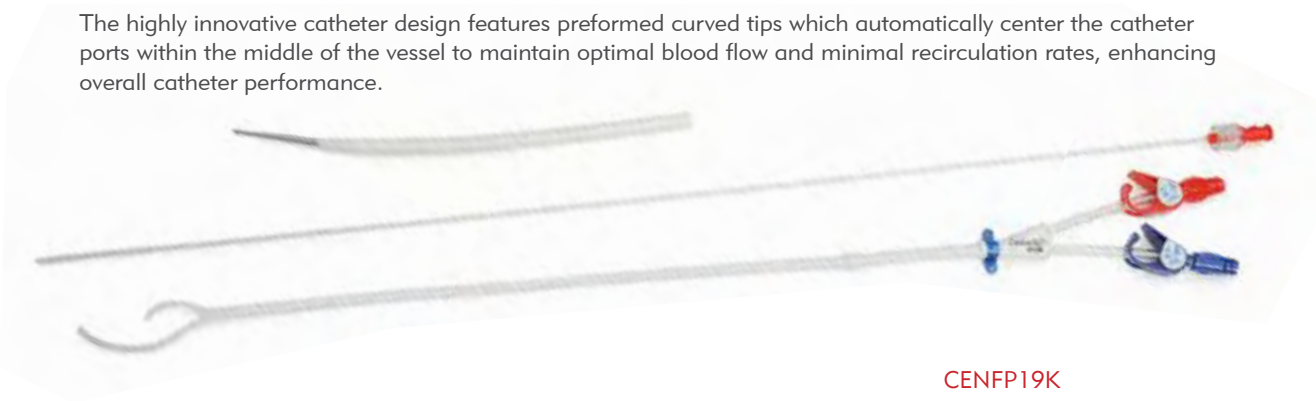

CENFP19K

Catalogue Number	Description	Catheter Length Tip to Hub (cm)	Catheter Length Tip to Cuff (cm)	Side Holes
------------------	-------------	---------------------------------	----------------------------------	------------

CENTROSFLO

CENFP15K	Complete Kit	20	15	yes
CENFP17K	Complete Kit	22	17	yes
CENFP19K	Complete Kit	24	19	yes
CENFP23K	Complete Kit	28	23	yes
CENFP27K	Complete Kit	32	27	yes
CENFP31K	Complete Kit	36	31	yes
CENFP15C	Catheter Only	20	15	yes
CENFP17C	Catheter Only	22	17	yes
CENFP19C	Catheter Only	24	19	yes
CENFP23C	Catheter Only	28	23	yes
CENFP27C	Catheter Only	32	27	yes
CENFP31C	Catheter Only	36	31	yes

CENTROS

CEN15K	Complete Kit	20	15	-
CEN17K	Complete Kit	22	17	-
CEN19K	Complete Kit	24	19	-
CEN23K	Complete Kit	28	23	-
CEN27K	Complete Kit	32	27	-
CEN31K	Complete Kit	36	31	-
CEN15C	Catheter Only	20	15	-
CEN17C	Catheter Only	22	17	-
CEN19C	Catheter Only	24	19	-
CEN23C	Catheter Only	28	23	-
CEN27C	Catheter Only	32	27	-
CEN31C	Catheter Only	36	31	-

Centros and CentrosFLO catheters do not have CE Marking.

COMPLETE KIT INCLUDES:

- 1 15F Long-Term Haemodialysis Catheter
- 1 Stiffening Stylet
- 1 16F Valved Peelaway Sheath and Dilator
- 1 18G x 2.75" (7 cm) Introducer Needle
- 1 #11 Futura® Safety Scalpel
- 1 0.038" x 80 cm J-Tipped Guide Wire
- 2 Adhesive Dressings
- 2 Injection Caps
- 1 12F Vessel Dilator
- 1 14F Vessel Dilator
- 1 Tunneler with Sleeve

PROGUIDE™ CHRONIC DIALYSIS CATHETERS

The ProGuide chronic dialysis catheter is designed for optimal patient comfort, ease of insertion and low maintenance. Multiple kit options are available for insertions through a valved peel-away sheath or over-the-wire placements. The ProGuide is available in various catheter lengths.

Catalogue Number	Catheter Length Tip to Hub (cm)	Catheter Length Tip to Cuff (cm)	Side Holes
63124	24	19	yes
63128	28	23	yes
63132	32	27	yes
63136	36	31	yes
63140	40	35	yes
64124	24	19	no
64128	28	23	no
64132	32	27	no
64136	36	31	no
64140	40	35	no

Packaged 5 per box.

CATHETER ONLY INCLUDES:

- 1 14.5F ProGuide Chronic Dialysis Catheter
- 1 Guide Wire Stylet
- 2 Injection Caps



PROGUIDE™ CHRONIC DIALYSIS CATHETER - BASIC KITS

Catalogue Number	Catheter Length Tip to Hub (cm)	Catheter Length Tip to Cuff (cm)	Side Holes
61124	24	19	yes
61128	28	23	yes
61132	32	27	yes
61136	36	31	yes
61140	40	35	yes
62124	24	19	no
62128	28	23	no
62132	32	27	no
62136	36	31	no
62140	40	35	no

Packaged 5 per box.

BASIC KIT INCLUDES:

- 1 14.5F ProGuide Chronic Dialysis Catheter
- 1 Guide Wire Stylet
- 2 Injection Caps
- 1 12F Vessel Dilator
- 1 14F Vessel Dilator
- 1 Tunneler with Sleeve



PROGUIDE™ CHRONIC DIALYSIS CATHETER - COMPLETE KITS

Catalogue Number	Catheter Length Tip to Hub (cm)	Catheter Length Tip to Cuff (cm)	Side Holes
DC21452419	24	19	yes
DC21452823	28	23	yes
DC21453227	32	27	yes
DC21453631	36	31	yes
DC21454035	40	35	yes
DC21455550	55	50	yes
DC01452419	24	19	no
DC01452823	28	23	no
DC01453227	32	27	no
DC01453631	36	31	no
DC01454035	40	35	no
DC01455550	55	50	no

Packaged 5 per box.

COMPLETE KIT INCLUDES:

- 1 14.5F ProGuide Chronic Dialysis Catheter
- 1 Guide Wire Stylet
- 1 15F Valved Peel-away Sheath and Dilator
- 1 18G x 2.75" (7 cm) Introducer Needle
- 1 #11 Futura® Safety Scalpel
- 1 0.038" (0.97 mm) J-Tipped Marker Guide Wire
- 2 Adhesive Dressings
- 2 Injection Caps
- 1 12F Vessel Dilator
- 1 14F Vessel Dilator
- 1 Tri-Ball Tunneler with Sleeve



PROGUIDE™ CHRONIC DIALYSIS CATHETER - COMPLETE KITS (INCLUDES MINI ACCESS KIT)

Catalogue Number	Catheter Length Tip to Hub (cm)	Catheter Length Tip to Cuff (cm)	Side Holes
DC21452419-NE5	24	19	yes
DC21452823-NE5	28	23	yes
DC21453227-NE5	32	27	yes
DC01452419-NE5	24	19	no
DC01452823-NE5	28	23	no
DC01453227-NE5	32	27	no

Packaged 5 per box.

COMPLETE KIT INCLUDES:

- 1 14.5F ProGuide Chronic Dialysis Catheter
- 1 Guide Wire Stylet
- 1 15F Valved Peel-away Sheath and Dilator
- 1 18G x 2.75" (7 cm) Introducer Needle
- 1 #11 Futura® Safety Scalpel
- 1 0.038" (0.97 mm) J-Tipped Marker Guide Wire
- 2 Adhesive Dressings
- 2 Injection Caps
- 1 12F Vessel Dilator
- 1 14F Vessel Dilator
- 1 Tri-Ball Tunneler with Sleeve



MINI ACCESS KIT (MAK) INCLUDES:

- 1 5F (1.7 mm) x 10 cm Coaxial Introducer
- 1 21G x 7 cm Echo-Enhanced Needle
- 1 0.018" (0.46 mm) x 40 cm Nitinol Wire with Platinum Tip

OUTAKE® CATHETER EXTRACTION TOOL

The OuTake catheter extraction tool is a convenient, simple, and cost-effective device used to remove tunneled, double lumen haemodialysis catheters with an in-growth cuff. Packaged 5 per box.

Catalogue Number

CET100	Standalone OuTake Catheter Extractor
CET200	Catheter Extraction Kit with OuTake
CET300	Catheter Extraction Kit without OuTake

Catheter Extraction Kits CET200 and CET300 do not have CE Marking.



PERITONEAL DIALYSIS CATHETERS

Merit Medical's line of Flex-Neck® Adult, Adolescent and Paediatric Peritoneal Dialysis (PD) Catheters have an internal diameter (ID) that is 35% larger than some competing catheters. Infant catheters are available in one- and two- cuff configurations. Each catheter kit contains a unique stenciling system for improved placement accuracy. Packaged 1 unit per box.



Catalogue Number	O.D. (mm)	I.D. (mm)	Distance Between Cuffs (cm)	Distance From Distal Cuff To Coil (cm)	Overall Length Straightened (cm)	Description
FLEX-NECK® INFANT COILED						
CF-4230	3.7	2.5	3	4.5	42	Classic, 2 cuffs
CF-4235	3.7	2.5	-	4.5	42	Classic, 1 cuff
CF-4430	3.7	2.5	3	4.5	42	ARC, 2 cuffs
FLEX-NECK PAEDIATRIC COILED						
CF-5242	5.3	3.5	4	6.5	52	Classic, 2 cuffs
CF-5247	5.3	3.5	-	6.5	52	Classic, 1 cuff
CF-5442	5.3	3.5	4.5	6.5	52	ARC, 2 cuffs
FLEX-NECK ADOLESCENT COILED						
CF-5243	5.3	3.5	4.5	9.5	62	Classic Standard, 2 cuffs
CF-5244	5.3	3.5	-	9.5	62	Classic Standard, 1 cuff
CF-5249	5.3	3.5	-	13.5	62	Classic Large, 1 cuff
CF-5443	5.3	3.5	4.5	9.5	52	ARC, 2 cuffs
FLEX-NECK CLASSIC ADULT COILED						
CF-5250	5.3	3.5	5	14	62	Small, 2 cuffs
CF-5260	5.3	3.5	6	15.5	62	Standard, 2 cuffs
CF-5270	5.3	3.5	7	16.5	62	Large, 2 cuffs
FLEX-NECK CLASSIC ADULT STRAIGHT						
CF-5161	5.3	3.5	6	15.5	52	Standard, cuffs (Distal Cuff to Tip)
FLEX-NECK ARC™ ADULT COILED						
CF-5450	5.3	3.5	6	14	62	Small, 2 cuffs
CF-5460	5.3	3.5	6	15.5	62	Standard, 2 cuffs
CF-5470	5.3	3.5	6	16.5	62	Large, 2 cuffs
FLEX-NECK EXXTENDED™ COILED ADULT						
CF-5560	5.3	3.5	-	16	62	

PERITONEAL DIALYSIS ACCESSORIES & IMPLANTATION SYSTEMS

Merit Medical offers a comprehensive line of Peritoneal Dialysis (PD) catheters, accessories, implantation systems, and an embedding tool to streamline your PD placement procedures.

Catalogue Number	Description	Quantity Per Box
CC-1301	PD Accessories, Plastic Catheter Connector and Cap, Adult/Adolescent/Paediatric	5
CC-1360	PD Accessories, Plastic Catheter Connector and Cap, Infant Only	5
CC-2300	PD Accessories, Titanium Catheter Connector, Adult	1
CE-1400	PD Accessories, Catheter Extender/Repair Kit, All Catheter Types	1
CS-242	PD Accessories, Catheter Implantation Stylet, Infant, Stainless Steel	1
CS-352	PD Accessories, Catheter Implantation Stylet, Adult Staight/Paediatric	1
CS-362	PD Accessories, Catheter Implantation Stylet, Adolescent/Adult	1
FT-1100	PD Accessories, Faller Trocar, Stainless Steel	1
IA-102	PD Accessories, Insufflation Kit	5
TE-1000	PD Accessories, Embedding® Tool	1
VP-210	Peritoneoscopic and Laparoscopic Implantation System	1
VP-511	Peritoneoscopic Implantation System	1

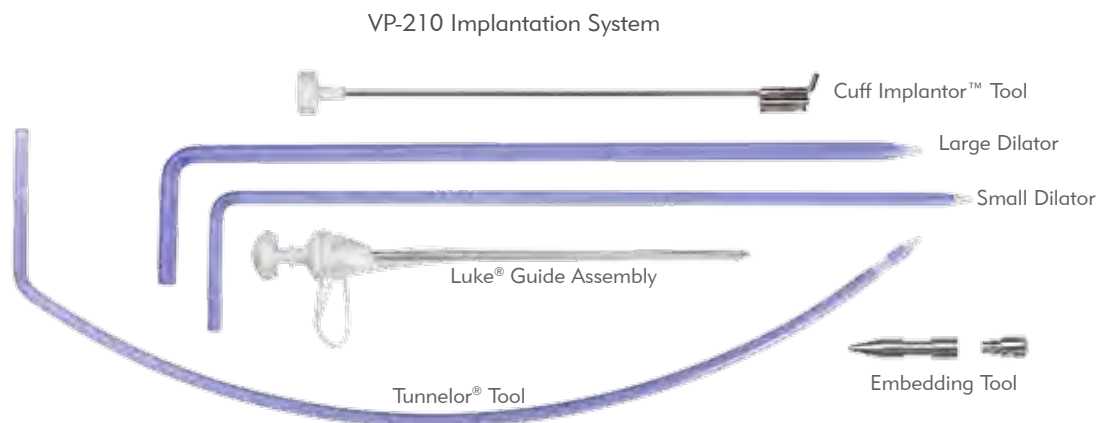

VP-511 Peritoneoscopic Implantation System

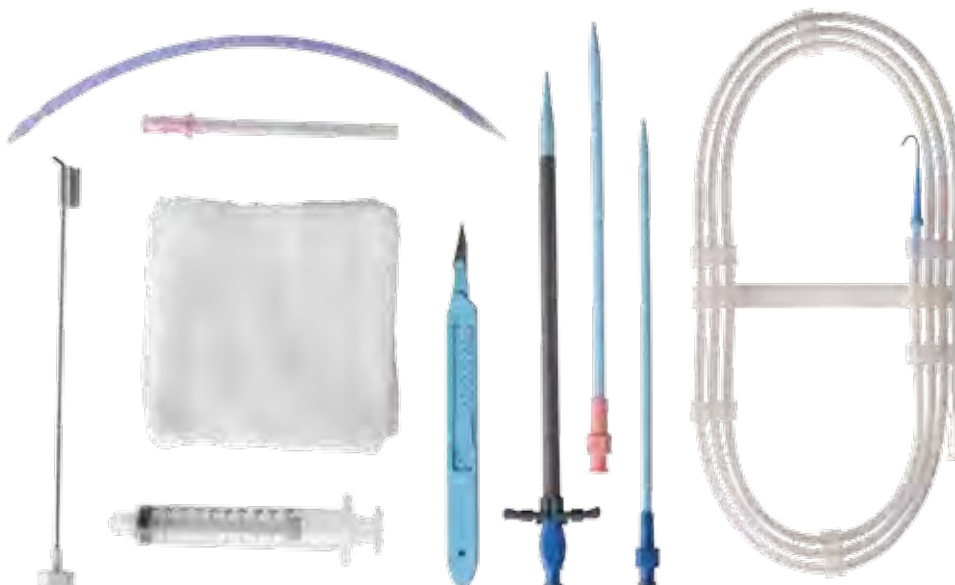

SLIP-NOT® SUTURE RETENTION DEVICE

The Slip-Not suture retention device helps manage bleeding by utilising a novel method to secure your purse-string suture. Suture tension adjustments are achieved at the push of a button. The Slip-Not provides clear visibility of the access site and enhanced patient comfort. Packaged 1 or 2 units per pouch, 10 pouches per box.

Easy, Step-by-Step Instructions

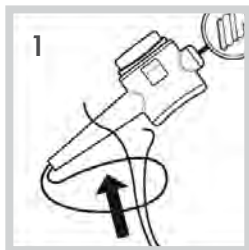

Place purse-string suture around the sheath; feed free ends of the suture through the snare loop of the device.

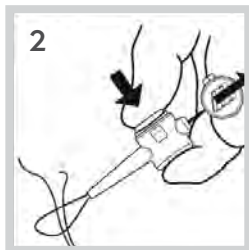

Depress the white button; pull the green tab to thread the free ends of the suture through the device. Discard green pull tab.

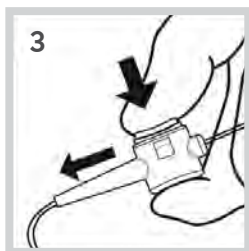

Depress the white button and slide the Slip-Not® forward to produce tension. Release the white button to secure the suture within the device.



Catalogue Number

SRD100	1 per pouch
SRD200	2 per pouch

4 FRENCH FOUNTAIN® INFUSION SYSTEMS

The Fountain Infusion System consists of the 4 French Fountain Infusion Catheter, matching occluding wire, high pressure check relief valve, AccessPLUS™ haemostasis valve, 1 mL infusion syringe and 20 mL reservoir syringe. Packaged and sold individually in tray, 5 units per box.



Catheter Length	Infusion Length 5 cm	Infusion Length 10 cm	Infusion Length 20 cm	Infusion Length 30 cm	Infusion Length 40 cm	Infusion Length 50 cm
45 cm		FIS4-45-10	FIS4-45-20			
90 cm	FIS4-90-5	FIS4-90-10	FIS4-90-20	FIS4-90-30	FIS4-90-40	FIS4-90-50
135 cm	FIS4-135-5	FIS4-135-10	FIS4-135-20	FIS4-135-30	FIS4-135-40	FIS4-135-50

4 FRENCH FOUNTAIN® INFUSION SYSTEMS WITH SQUIRT®

The Fountain Infusion System with Squirt consists of the 4 French Fountain Infusion Catheter, matching occluding wire, AccessPLUS haemostasis valve, 20 mL reservoir syringe and Squirt® fluid dispensing system. Packaged and sold individually in tray, 5 units per box.

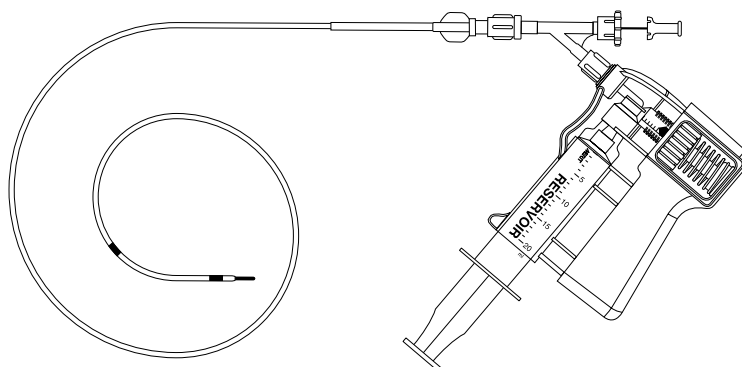

Catheter Length	Infusion Length 5 cm	Infusion Length 10 cm	Infusion Length 20 cm	Infusion Length 30 cm	Infusion Length 40 cm	Infusion Length 50 cm
45 cm		FIS4-45-10SQ	FIS4-45-20SQ			
90 cm	FIS4-90-5SQ	FIS4-90-10SQ	FIS4-90-20SQ	FIS4-90-30SQ	FIS4-90-40SQ	FIS4-90-50SQ
135 cm	FIS4-135-5SQ	FIS4-135-10SQ	FIS4-135-20SQ	FIS4-135-30SQ	FIS4-135-40SQ	FIS4-135-50SQ

5 FRENCH FOUNTAIN® INFUSION SYSTEMS

The Fountain Infusion System consists of the 5 French Fountain Infusion Catheter, matching occluding wire, high pressure check relief valve, AccessPLUS™ haemostasis valve, wire protector cap, 1 mL infusion syringe and 20 mL reservoir syringe. Packaged and sold individually in tray, 5 units per box.

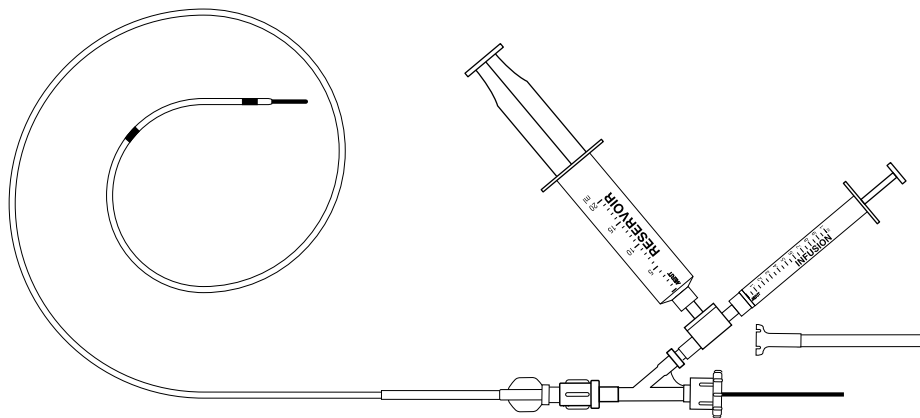

Catheter Length	Infusion Length 5 cm	Infusion Length 10 cm	Infusion Length 20 cm	Infusion Length 30 cm	Infusion Length 40 cm	Infusion Length 50 cm
45 cm		FIS5-45-10	FIS5-45-20			
90 cm	FIS5-90-5	FIS5-90-10	FIS5-90-20	FIS5-90-30	FIS5-90-40	FIS5-90-50
135 cm	FIS5-135-5	FIS5-135-10	FIS5-135-20	FIS5-135-30	FIS5-135-40	FIS5-135-50

5 FRENCH FOUNTAIN® INFUSION SYSTEMS WITH SQUIRT®

The Fountain Infusion System with Squirt consists of the 5 French Fountain Infusion Catheter, matching occluding wire, AccessPLUS haemostasis valve, wire protector cap, 20 mL reservoir syringe and Squirt® fluid dispensing system. Packaged and sold individually in tray, 5 units per box.

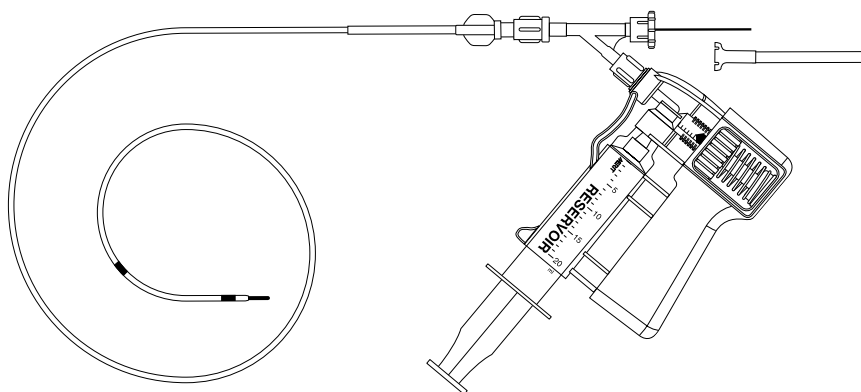

Catheter Length	Infusion Length 5 cm	Infusion Length 10 cm	Infusion Length 20 cm	Infusion length 30 cm	Infusion Length 40 cm	Infusion Length 50 cm
45 cm		FIS5-45-10SQ	FIS5-45-20SQ			
90 cm	FIS5-90-5SQ	FIS5-90-10SQ	FIS5-90-20SQ	FIS5-90-30SQ	FIS5-90-40SQ	FIS5-90-50SQ
135 cm	FIS5-135-5SQ	FIS5-135-10SQ	FIS5-135-20SQ	FIS5-135-30SQ	FIS5-135-40SQ	FIS5-135-50SQ

FOUNTAIN® INFUSION CATHETERS

FOUNTAIN INFUSION CATHETER (4 FRENCH) matching occluding wire and AccessPLUS™ haemostasis valve. Packaged and sold individually in a pouch, 5 units per box.

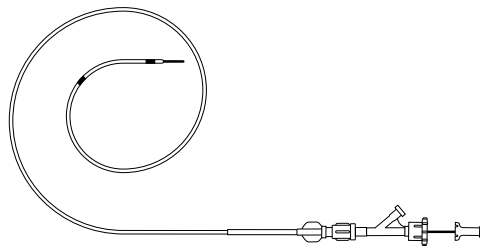

Catheter Length	Infusion Length 5 cm	Infusion Length 10 cm	Infusion Length 20 cm	Infusion Length 30 cm	Infusion Length 40 cm	Infusion Length 50 cm
45 cm		IS4-45-10	IS4-45-20			
90 cm	IS4-90-5	IS4-90-10	IS4-90-20	IS4-90-30	IS4-90-40	IS4-90-50
135 cm	IS4-135-5	IS4-135-10	IS4-135-20	IS4-135-30	IS4-135-40	IS4-135-50

FOUNTAIN INFUSION CATHETER (5 FRENCH) matching occluding wire, AccessPLUS haemostasis valve, and wire protector cap. Packaged and sold individually in a pouch, 5 units per box.

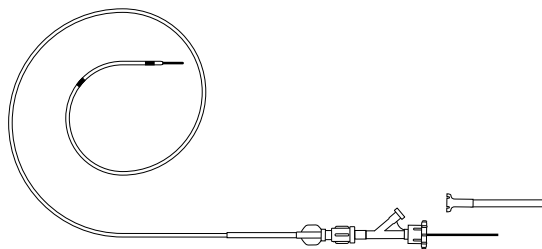

Catheter Length	Infusion Length 5 cm	Infusion Length 10 cm	Infusion Length 20 cm	Infusion Length 30 cm	Infusion Length 40 cm	Infusion Length 50 cm
45 cm		IS5-45-10	IS5-45-20			
90 cm	IS5-90-5	IS5-90-10	IS5-90-20	IS5-90-30	IS5-90-40	IS5-90-50
135 cm	IS5-135-5	IS5-135-10	IS5-135-20	IS5-135-30	IS5-135-40	IS5-135-50

FOUNTAIN® OCCLUDING WIRES

The Fountain occluding wire effectively blocks off the end hole of the catheter so the therapeutic agent is directed out the side holes into the thrombus. Packaged and sold individually in a pouch, 5 units per box.

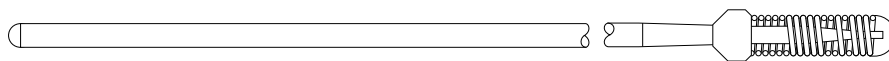

	Length 45 cm	Length 90 cm	Length 135 cm
4F Wire	FW4-45	FW4-90	FW4-135
5F Wire	FW5-45	FW5-90	FW5-135

SQUIRT® FLUID DISPENSING SYSTEM

The Squirt fluid dispensing system for the pulsed injection of multiple-dose therapy. Packaged 10 units per box.

Catalogue Number FDS100

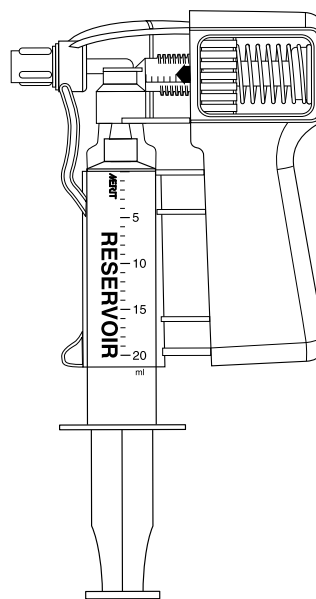

PULSE INFUSION KITS

Pulse Infusion Kits are designed to be used with the Fountain® and Mistique® infusion catheters. Products are available with 1 mL infusion syringe, 20 mL reservoir syringe, and check relief valve; some kits also contain a haemostasis valve.

PULSE INFUSION KIT consists of in-line check relief valve, AccessPLUS™ haemostasis valve, 1 mL infusion syringe and 20 mL reservoir syringe. Packaged 5 units per box.

Catalogue Number K12-00462

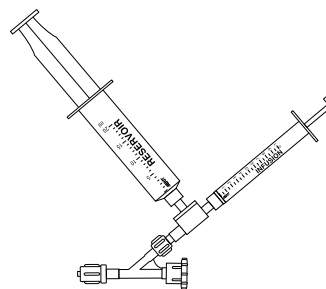

PULSE INFUSION KIT consists of in-line check relief valve, 1 mL infusion syringe and 20 mL reservoir syringe. Packaged 5 units per box.

Catalogue Number K12-00463

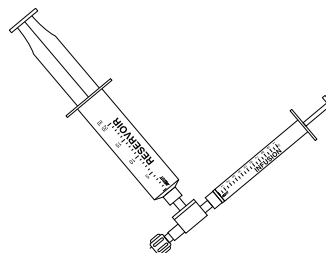

PULSE INFUSION KITS

PULSE INFUSION KIT consists of check relief valve, 1 mL infusion syringe and 20 mL reservoir syringe. Packaged 5 units per box.

Catalogue Number K12-00262

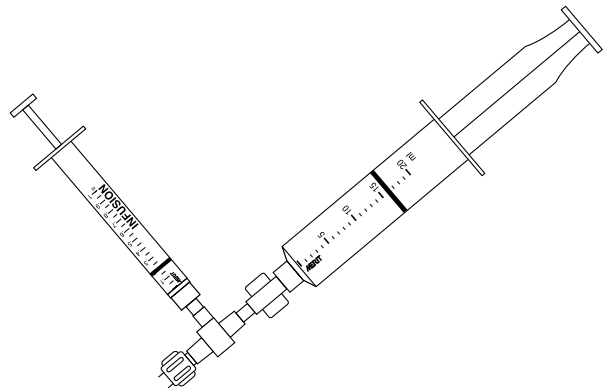

MISTIQUE® INFUSION CATHETERS

The Mistique infusion catheter is a 5 French catheter with side holes rotating around the catheter for a more uniform distribution of therapeutic solutions. One configuration to accommodate 0.035" (0.89 mm) guide wire. Packaged and sold individually, 5 units per box.

Catheter Length	Infusion Length 5 cm	Infusion Length 10 cm
	MAXIMUM GUIDE WIRE 0.035" (0.89 mm)	
45 cm	MIC5-45-5-035	MIC5-45-10-035
90 cm	MIC5-90-5-035	MIC5-90-10-035
135 cm	MIC5-135-5-035	MIC5-135-10-035

